

Data Sheet



Article number: 12621000180710

Description: Threaded pin 621 000 180.710
For M18

Measures

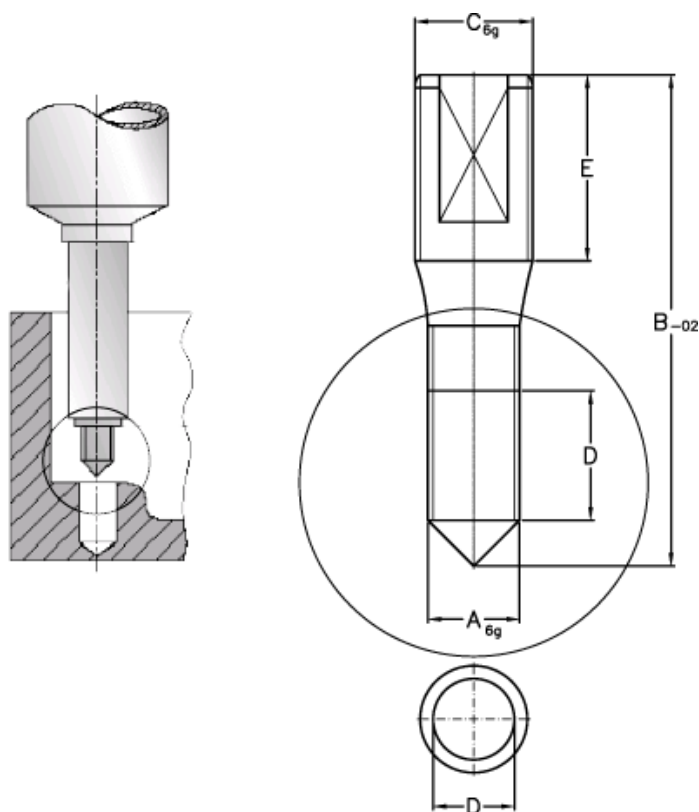

A = M18
B = 148.0
C = M18
D = 36.0
E = 32